

**ANDHRA PRADESH EDUCATION & WELFARE
INFRASTRUCTURE DEVELOPMENT CORPORATION**



AGREEMENT

Name of the work : Procurement of Double Skin Powder Coated GI openable / casement single rebate Windows with 5 mm thick polycarbonate sheet size of window 1.50 M x 1.35 M (three openable shutters) including supply and fixing to the Government Schools (Educational Institutions) of YSR Kadapa, Annamayya, Ananthapuram, Sri Satya Sai, Chittoor and Tirupathi (6) Districts as Package-IV in Andhra Pradesh under MANABADI NADU-NEDU Phase-II

Estimate Cost: Rs. 86.91 Crores

Name of the Contractor: M/s. AHLADA ENGINEERS LIMITED,
D.No.4-56,Sy No:62/1/A & 67,
Tech Mahindra Road, Bahadurpally Village,
Dundigal, (Gandimysamma) Mandal, Medchal
Malkajgiri District, Hyderabad-500043.

**O/o THE MANAGING DIRECTOR,
APEWIDC, Vaddeswaram (V)Tadepally (M), Guntur**

Annexure-A

SCHEDULE-A

S.No	Qty in sqm	Item Description	Rate per Sqm	Amount Rs.
1	59194.80	<p>Supply and fixing of Double Skin powder coated GI openable/casement single rebate Windows with 5mm thick Polycarbonate sheet SIZE OF WINDOW 1.50 M X 1.35M (three openable shutters) Providing and fixing of powder coated Openable/Casement GI Window of size 1.50mx1.35m (three openable shutters). Window frame having two horizontals & four verticals (Base steel as per IS513 of 0.60mm thick galvanized as per IS 277 with Zinc of 120 GSM), powder coated paint of 60-65microns(DFT) thick and section for double Skin outer frame of 80 mm x 65 mm x 0.6mm thick including architrave of 20mm,centre mullions of 80mm x 60mm x 0.6mm thick and section for Double Skin shutter of 52mm x25 mm x 0.6 mm thick, outer frame and mullions to have rebate for glazed shutter and the sections cut to length metre joined with corner bracket, center mullion fixed with mullion cap, shutter with 5mm thick Polycarbonate Solid clear UV resistant sheet of reputed make (UV stabilized, transparent & solid section) with EPDM rubber gaskets including fixing the frames in concrete/masonry wall by means of self-expanding screws, Including 10mm Square guard bars with 14Nos horizontals & two verticals, ' the window shutter shall be provided with suitable size U shaped EDPM gasket to hold the Polycarbonate sheet , including infill material of polyurethane foam (PUF) and all fixers like 100mm long SS handle -3 Nos, 125mm long SS tower bolts-6Nos, 75mm long SS ball bearing butt Hinges-9Nos, 200mm long SS latch type window stopper -3Nos (all fixers should be stainless steel 304 grade) including all stiffeners ,supporting plates, SS 304 screws, Nylon caps, EPDM rubber gasket etc., complete for finished item of work. and including cost & conveyance of all materials and all labour charges like loading, unloading, and fixing of powder coated Galvanized Steel Window etc., complete for finished item of work.</p> <p>Window Frame: Frame having four verticals & two horizontals, around frame section of size;80mmx65mm x 0.6mm thick including architrave of 20mm and center mullions section of size; 80mmx60mm x0.6mm thick. (2Nos), with single rebate.</p> <p>Shutters (3 Nos): Shutter section of size 52mm x25 mm x 0.6 mm thick with 5mm thick Polycarbonate Solid Clear UV resistant sheet of reputed make (UV stabilized, transparent & solid section)</p> <p>Infill Material: polyurethane foam (PUF)</p>	15252.44	90,28,68,185.80 (Rupees Ninety Crores Twenty Eight Lakhs Sixty Eight thousand one hundred eighty five and paise eighty only)

For AHILADA ENGINEERS LTD

Authorized Signatory of the
Firm/Company

[Signature]
Authorized Signatory

21

Managing Director
APEWIDC, Vijayawada

[Signature]
A
10
13/5/23

Grill: Grill having 14 Nos of 10mm sq rods (horizontals) and 2Nos of 10mm Sq rods (verticals), 10mm sq rods should be inserted into outer frame & center mullions as directed by the Engineering in charge,
Note; 4 Nos of 10mm sq rods should be inserted into outer frame & centre mullions (As per drawing shown below).

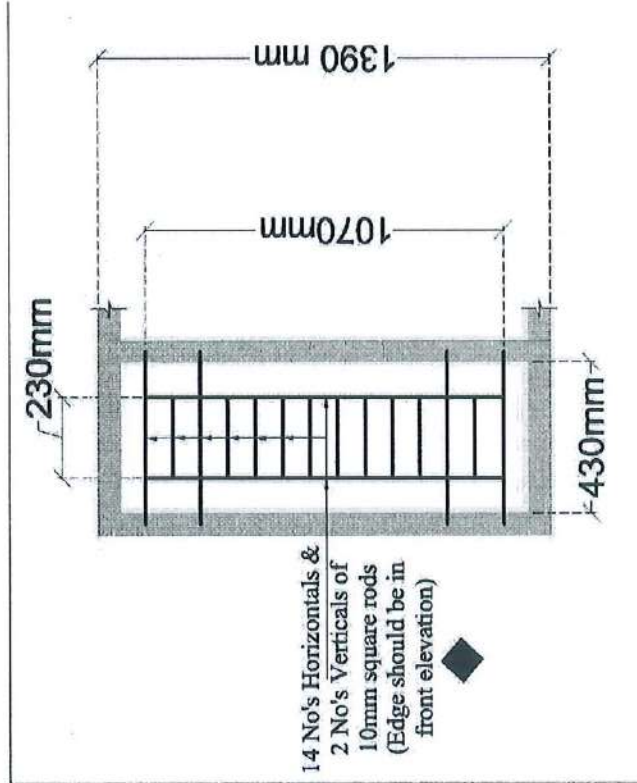

Fixers: 100mm long SS handle -3 Nos, 125mm long SS tower bolts-6 Nos, 75mm long SS ball bearing butt Hinges 9 Nos, 200mm long SS latch type window stopper -3 Nos

Note ; all fixers should be stainless steel 304

Rear Face of Window size : 1.50 MX 1.35 M

Front face of Window size : 1.54 MX 1.39 M (including Architrave)

FOR AHLADA ENGINEERS LTD.

Authorized Signatory of the Firm/Company
 Authorized Signatory

(Handwritten signature and date)
 13/5/23

(Handwritten initials)
 w
 A

	<p>The Window outer Frame, Mullions and Shutter frame shall be Closed Box profiles, using roll forming procedures . Suitable lock-seam joints shall be provided with proper stitching procedures. The process shall be carried out cold. No welding, no soldering, no screws, no bolt-nuts.</p> <p>Infill material of Polyurethane (PUF) shall be provided in Window frame Box Profile, Mullion Box Profile and Shutter Box Profile. Injected Polyurethane Foam (PUF) procedure shall be adopted. Density of PU-Foam shall be 32 to 36 kg/m³.</p> <p>The price/ rate per sqm is for the dimensional area of the outer to outer of window frame only i.e., Window opening area only (1.50 M X 1.35 M), excluding architrave. The rate will be measured, billed and paid for the area of 2.025 Sqm i.e. 1.50 mtrs X 1.35 mtrs .</p> <p>Weather Gasket for outer frame & Mullions: Groove in Frame and Mullion shall be provided to hold EDPM Gasket so that the shutters will not hit/rest on the frame and Mullion when the shutters are closed. The window shutter shall rest on the EDPM Gasket when closed. And to make the window as weather resistant.</p> <p>In the shutter suitable size u shaped EDPM gasket shall be provided to hold the Poly carbonate sheet firmly.</p> <p>Shall confirm to the BIS codes: -IS 1038:1983: Steel doors and windows, IS 4351:2003: Steel Door and window shutters, IS 13871:1993: Powder coating, IS 277: Galvanized Steel Sheets, IS 513: Cold reduced low carbon steel sheets IS ; 1081: Fixing and glazing of Steel Doors and Windows, IS 14443 (1997): Polycarbonate sheets, IS12436:1988 for PUF and all other relevant codes of BIS.</p> <p><i>“Nadu – Nedu 2023” Logo shall be embossed and painted on the top of the Window frame in the middle, the size of logo shall be such that it is clearly visible.</i></p> <p>This Item shall carry a warranty period of 5 (Five) Years from the date of completion of supply and fixing.</p>	
	<p>Grand Total (Including GST and all other Taxes etc.,)</p>	<p>Rs. 90,28,68,185.80 (Rupees Ninety Crores Twenty Eight Lakhs Sixty Eight thousand one hundred eighty five and paise eighty only)</p>

For AHLADA ENGINEERS LTD.

Authorized Signature of the Firm/Company
Authorized Signatory

Managing Director
APEWIDC, Vijayawada

(Handwritten signature and date 23/5/23)

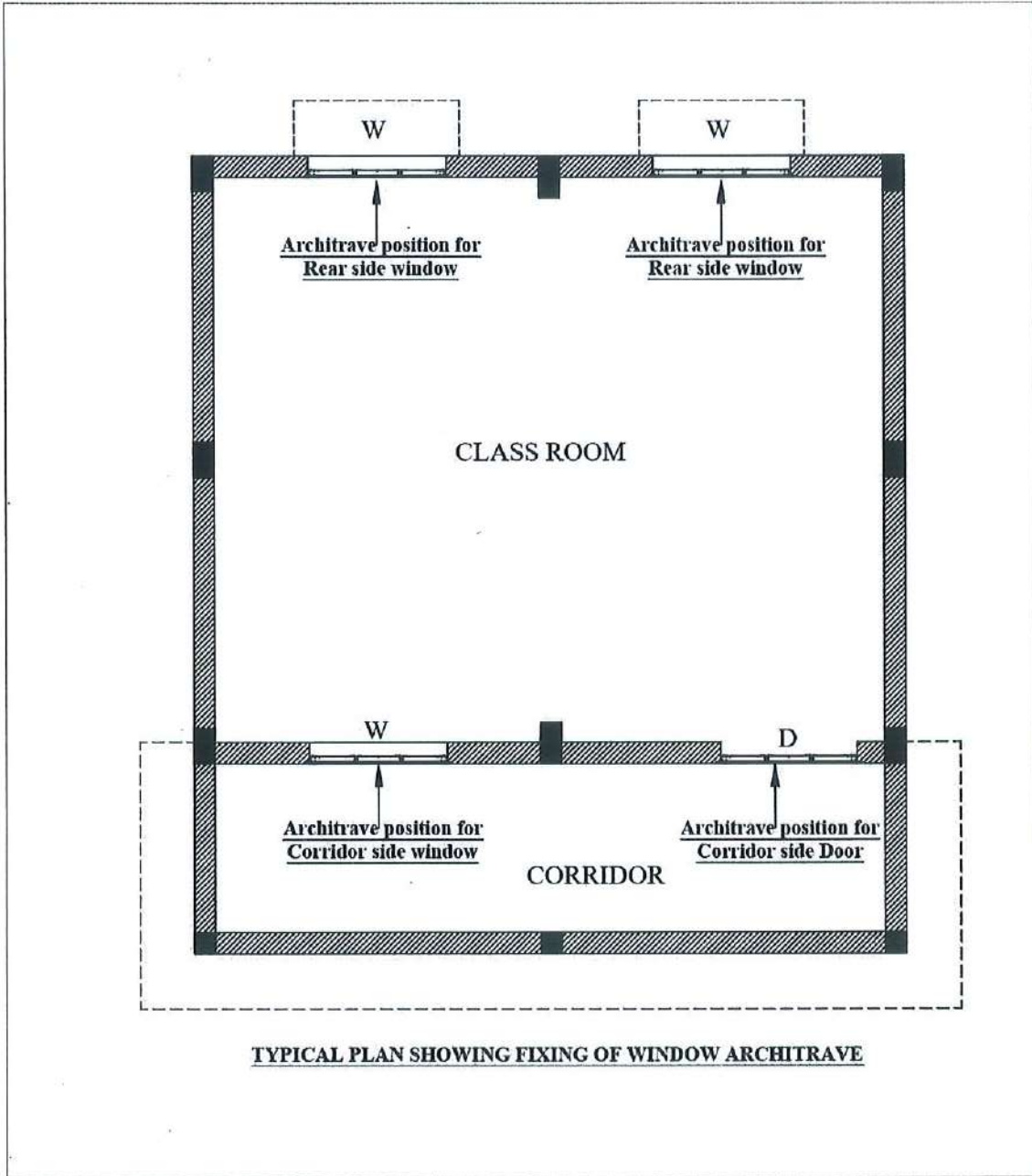

For AHLADA ENGINEERS LTL.

[Handwritten signature]

Authorized Signature of the Firm/Company

[Handwritten signature]
 Managing Director
 APEWIDC, Vijayawada

[Handwritten initials and date]
 A M 9/3/23

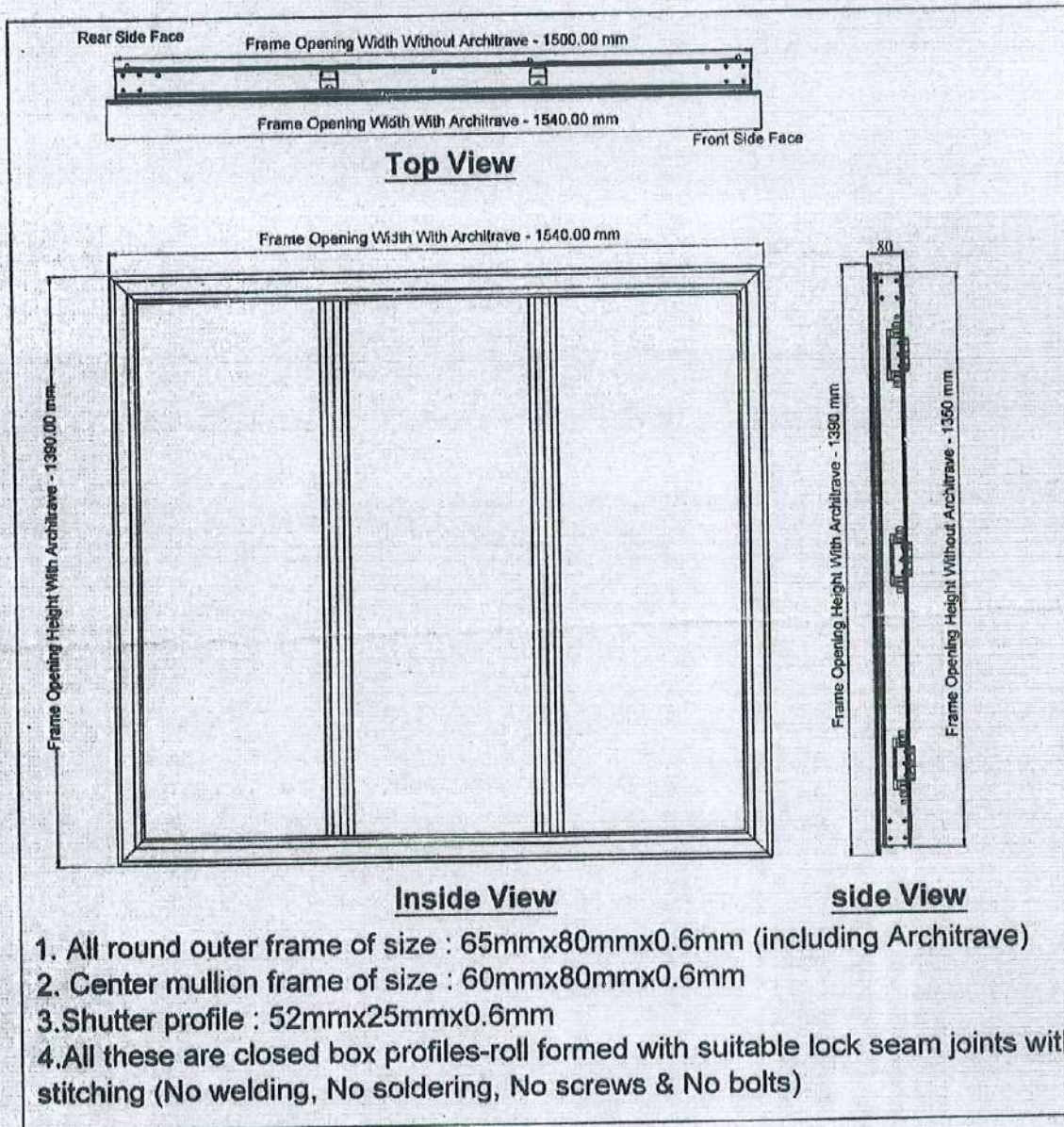

For AHLADA ENGINEERS L11

 Authorized Signature of the Firm/Company

 Managing Director
 APEWIDC, Vijayawada

A u 4/3/5/23

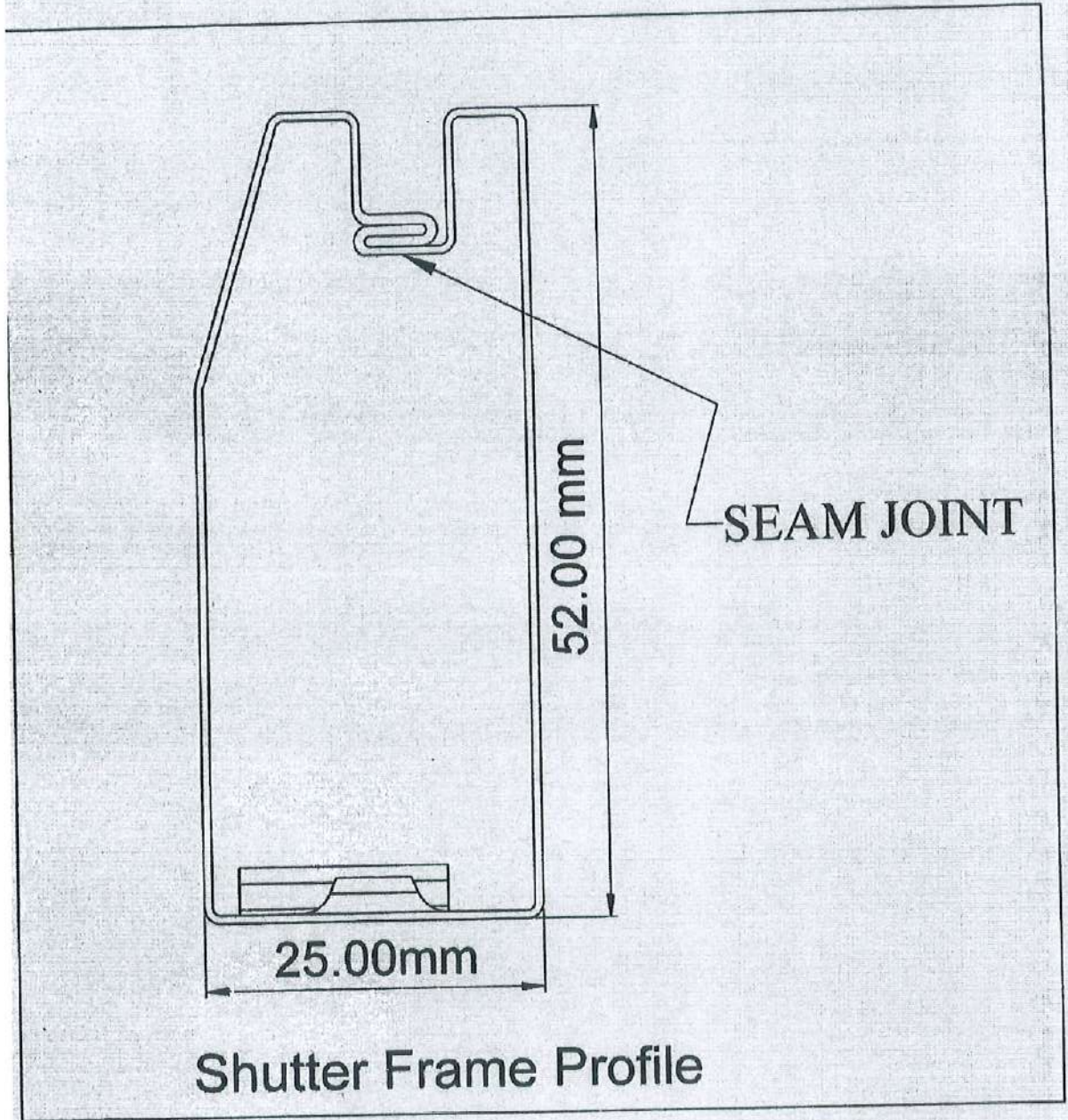

For AHLADA ENGINEERS LTD

Authorized Signatory of the Firm/Company

A *u* 4/3/5/23

Managing Director
APEWIDC, Vijayawada

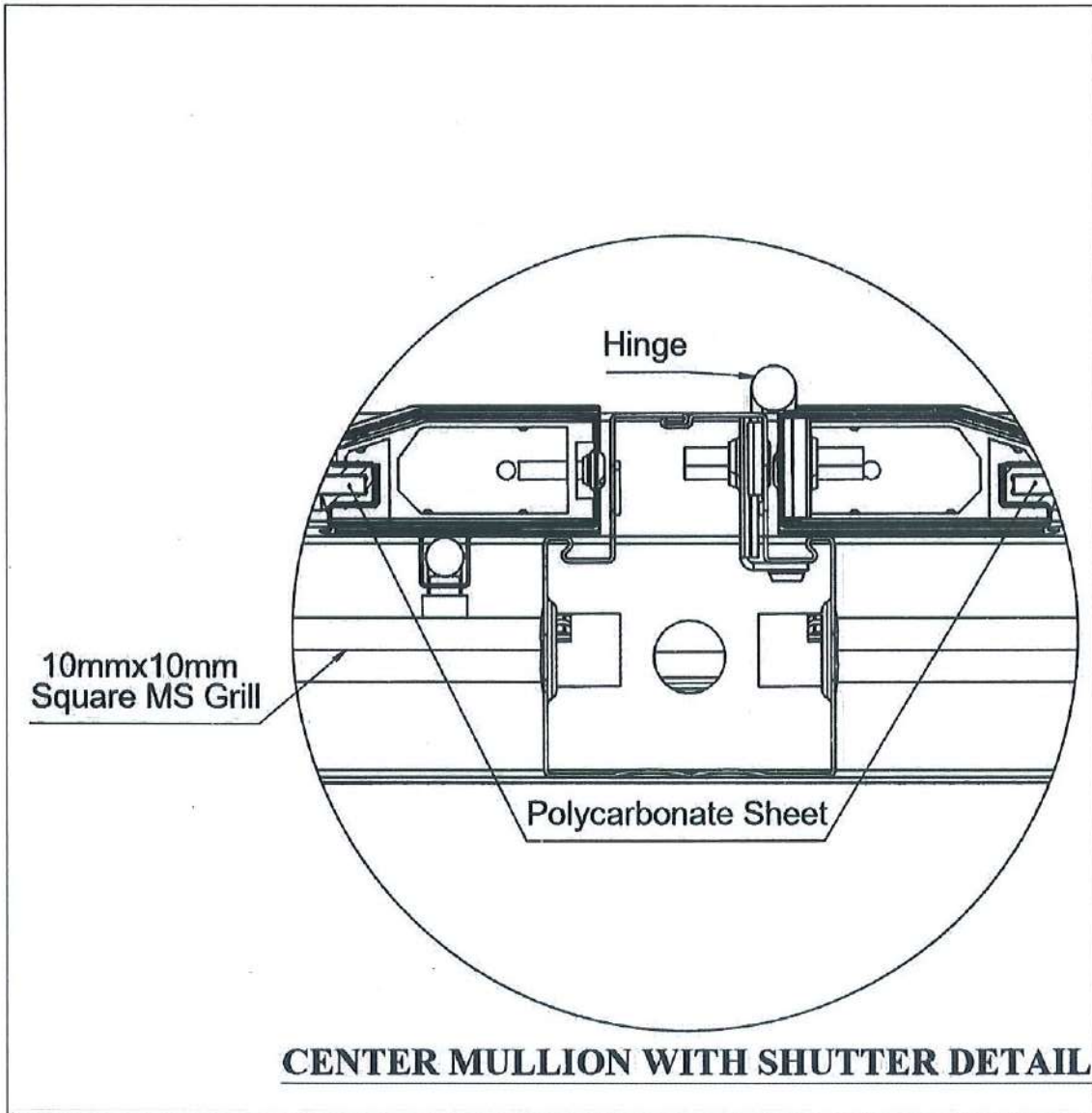

For AHLADA ENGINEERS LTD.

[Handwritten Signature]

Authorized Signatory of the Firm/Company

[Handwritten Signature]

Managing Director
APEWIDC, Vijayawada

[Handwritten Signature] 3/5/23

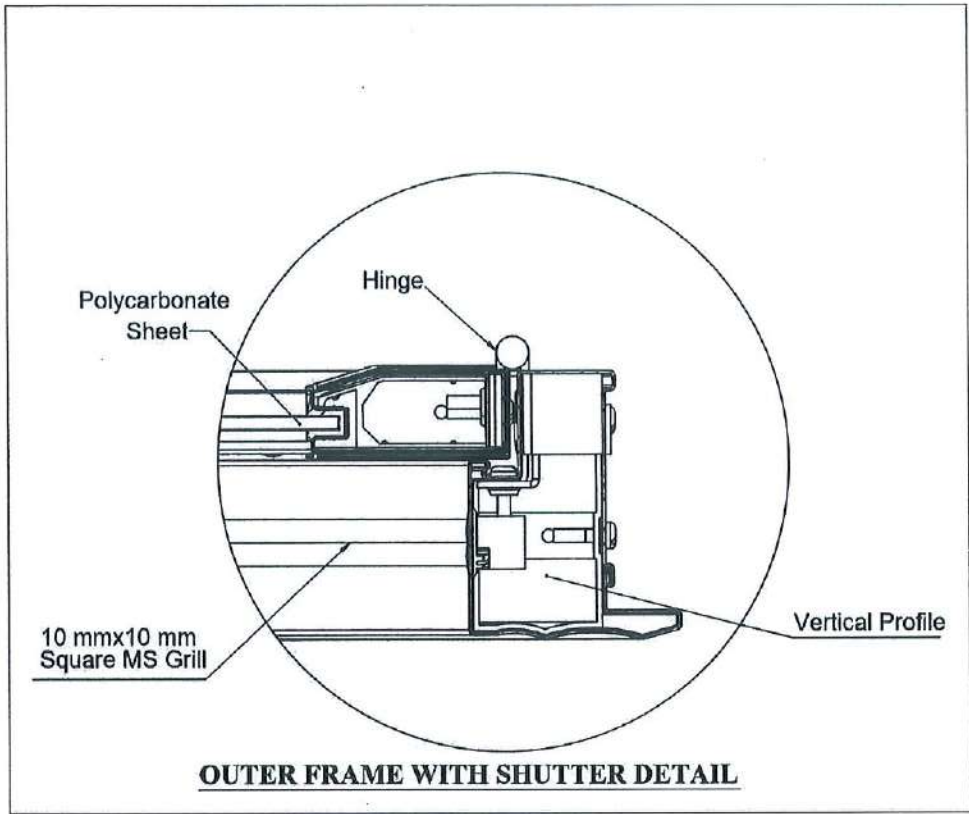

For AHLADA ENGINEERS LTD
[Handwritten Signature]
 Authorized Signatory of the Firm/Company

[Handwritten Signature]
 Managing Director
 APEWIDC, Vijayawada

[Handwritten Date]
 23/5/23

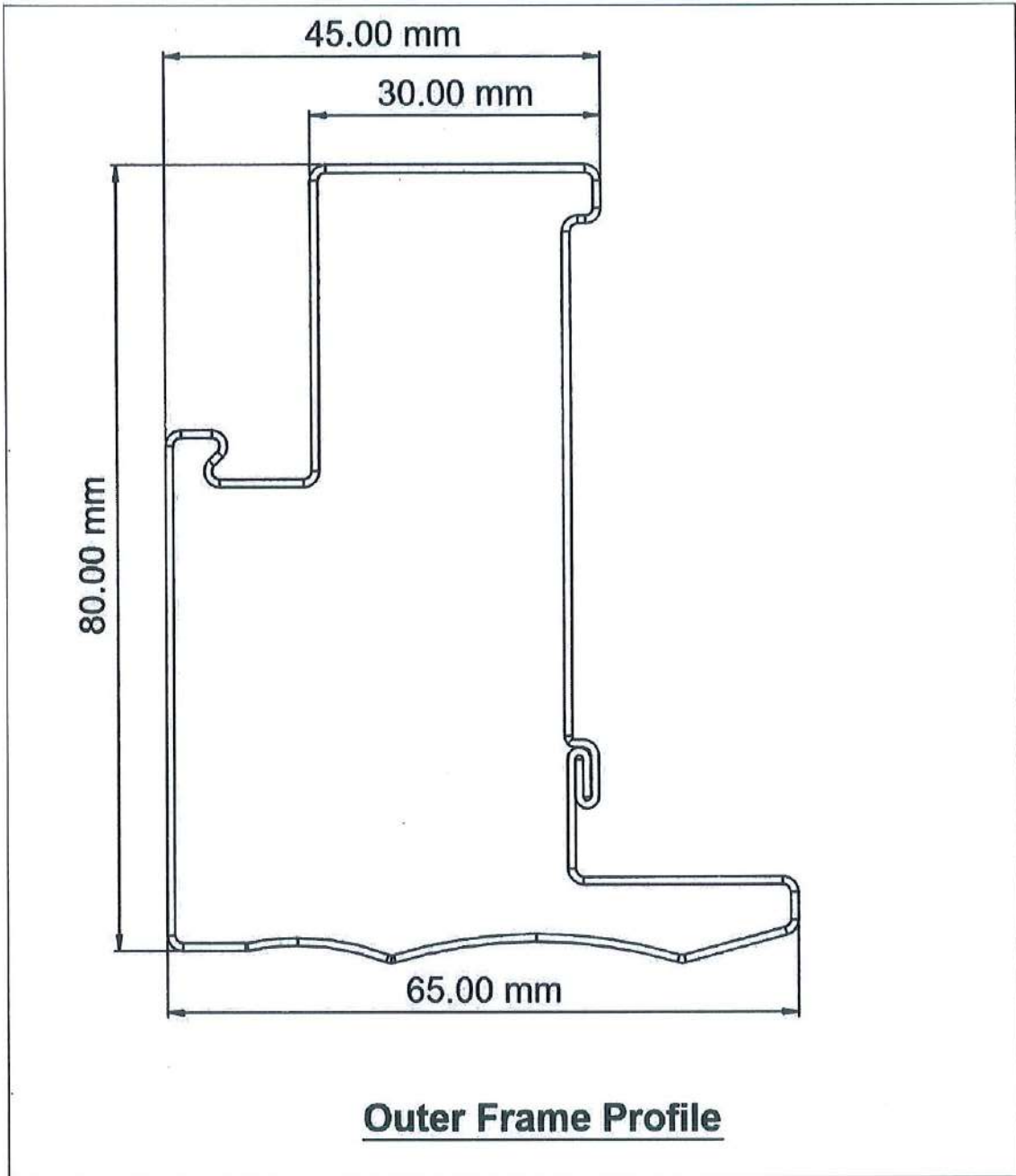

For AHLADA ENGINEERS LTD.

 Authorized Signatory of the Firm/Company

 Managing Director
 APEWIDC, Vijayawada

 9/3/5/23

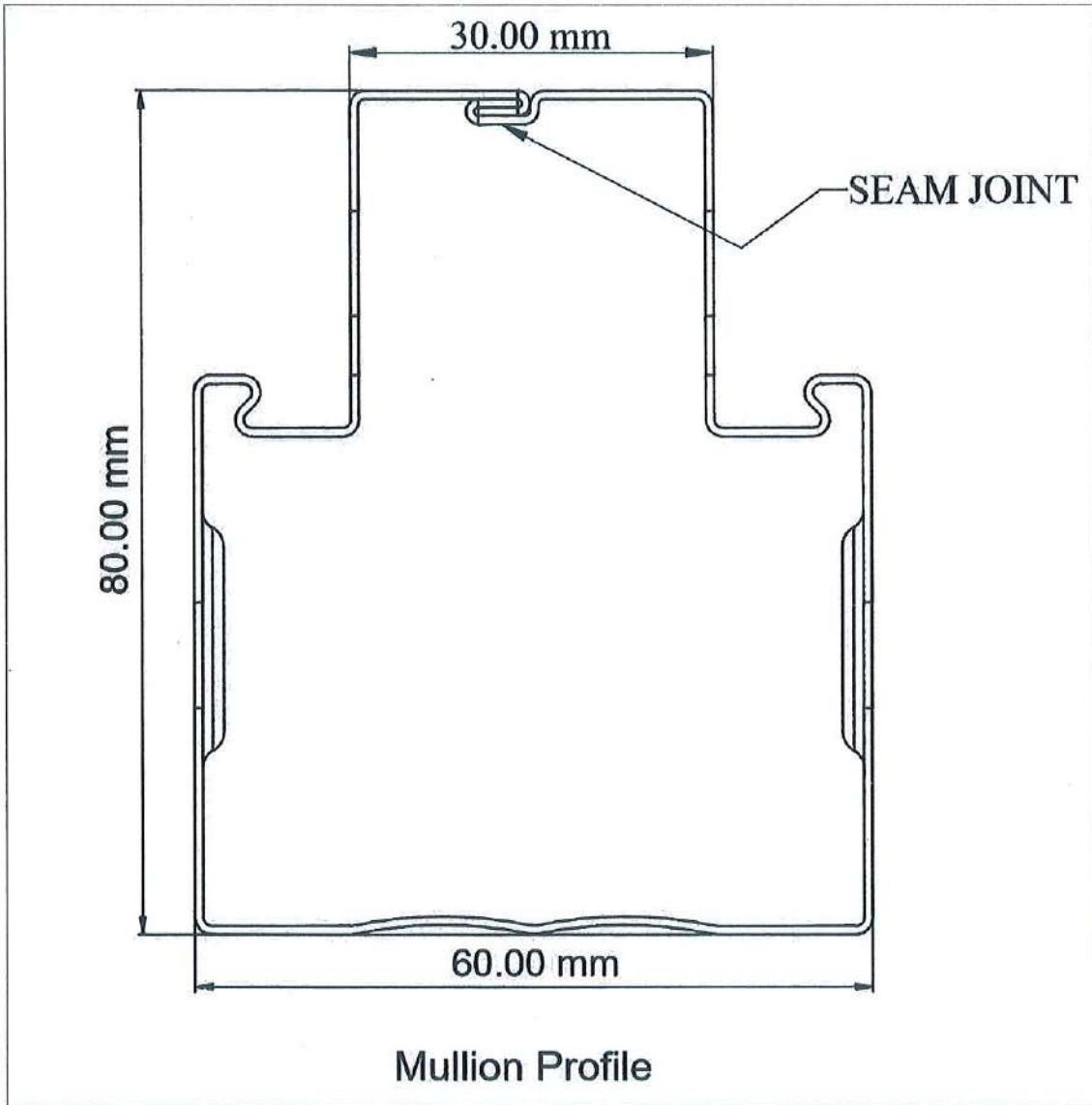

For AHLADA ENGINEERS PVT. LTD.

Authorized Signature of the Firm/Company

Managing Director
APEWIDC, Vijayawada

A m 9/3/5
23